

Laydown Grooving

For Shallow Grooves





METRIC

Laydown Grooving Ordering Code System

Insert

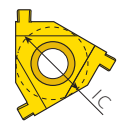
5	L	I	R	1.1	-	D472	-	1.3	VKP
1	2	3	4	5	6	7	6	8	9

1 - Insert Size 5.0L - IC5.0L 2 - IC1/4" 3 - IC3/8" 4 - IC1/2" 5 - IC5/8" 	2 - Insert Style L 	4 - RH / LH Insert R - Right Hand Insert L - Left Hand Insert 5 - Groove Std. Width 0.8 - 2.15 (mm) 6 - Profile Style C - Full Profile	7 - Groove Standard DIN 471 Partial DIN 471 DIN 472 Partial DIN 472 DIN 7993 Partial DIN 7993 DIN 76 ST, DIN 76 SH DIN 3770	8 - Groove Depth 0.33 - 2.0 (mm) 9 - Carbide Grade VTX VKP (for Mini L) VHX (for Mini L) VKX
--	---	---	--	--

External Toolholders

A	L	32	-	4	
1	2	3		4	5

1 - Anvil A - Anvil required N - No Anvil required O - Miniature holder	2 - Holder Style L - External V - Miniature Square Shank VR - Miniature Round Shank	3 - Shank Square [mm] 8, 10, 12, 16, 20, 25, 32, 40, 50, 60	4 - Insert Size 2 - IC1/4" 3 - IC3/8" 4 - IC1/2" 5 - IC5/8"	5 - RH/LH Holder None - Right Hand LH - Left Hand
---	---	--	--	--

Internal Toolholders

C	A	VR	C	20		-	3	
1	2	3	4	5	6		7	8

1 - Shank Type B - Anti Vibration System C - Carbide Shank S - Mini Holders	2 - Anvil A - Anvil required N - No Anvil required O - Miniature holder 3 - Tool Type VR - Internal Round shank	4 - Cooling C - With Coolant Channel 5 - Shank Front Dia 10, 10D, 12, 13, 16 16D, 20, 25, 25D, 32, 40, 50 6.2 (Mini Adjust) 8.0 (Mini Adjust)	6 - Holder Length (Mini Holders) U - Ultra Short S - Short M - Medium L - Long T - Adjustable	7 - Insert Size 5L - IC5.0L mm 4.0K - IC4.0 mm 6.0 - IC6.0 mm 2 - IC1/4" 3 - IC3/8" 4 - IC1/2" 5 - IC5/8"	8 - RH/LH Holder None - Right Hand LH - Left Hand
---	--	---	--	---	--

Adjustable Toolholders (Sleeves)

S	M	C	16	-	3
1	2	3	4		5

1 - Holder Shape S - Sleeve (Double Ended)	2 - Holder Type V - Adjustable Holders	3 - Cooling C - Coolant Channel	4 - Holder Dia. 10, 12, 16, 20	5 - Holder Bore Size Adjustable Holders 6.2 8
---	--	---	--	---

DIN 471 Retaining Ring Grooves for Shafts

External

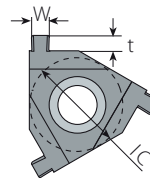
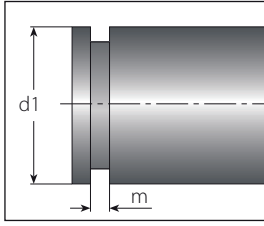

Standard
(Partial Profile)

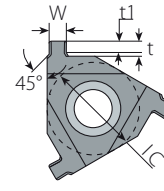

Standard
(Full Profile)

Standard (Partial Profile)



Insert Size	Ordering Code	Groove Std.	Dimensions mm			Anvil	Holder
IC	RH	m (H13)	W	t			
3/8"	3ER1.10-D471-1.30...	1.10	1.19	1.3			
	3ER1.30-D471-1.50...	1.30	1.39	1.5			
	3ER1.60-D471-1.85...	1.60	1.69	1.8	YE3M-1.5N	AL.-3	
	3ER1.85-D471-2.00...	1.85	1.94	2.0			

Range of profiles also available on IC 1/4", 1/2" and 5/8", inserts on request.

Standard (Full Profile)



Insert Size	Ordering Code	Groove Std.	Dimensions mm				Anvil	Holder
IC	RH	m(H13)	d1	W	t1	t		
3/8"	3ER1.10C-D471-0.35...	1.10	15	1.19	0.33	0.35		
	3ER1.10C-D471-0.40...	1.10	16-17	1.19	0.36	0.40		
	3ER1.30C-D471-0.50...	1.30	18-22	1.39	0.44	0.50		
	3ER1.30C-D471-0.55...	1.30	24-26	1.39	0.45	0.55		
	3ER1.60C-D471-0.70...	1.60	28-30	1.69	0.60	0.70	YE3M-1.5N	AL.-3
	3ER1.60C-D471-0.85...	1.60	32-34	1.69	0.75	0.85		
	3ER1.60C-D471-1.00...	1.60	35	1.69	0.85	1.00		
	3ER1.85C-D471-1.00...	1.85	36-38	1.94	0.85	1.00		
	3ER1.85C-D471-1.25...	1.85	40-48	1.94	1.10	1.25		
	3ER2.15C-D471-1.50...	2.15	50-63	2.24	1.35	1.50		

Range of profiles also available on IC 1/4", 1/2" and 5/8", inserts on request.

DIN 472 Retaining Ring Grooves for Bores

Internal

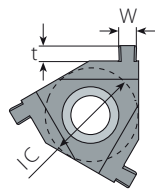
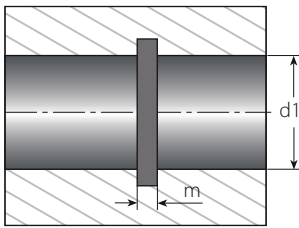

Standard
(Partial Profile)

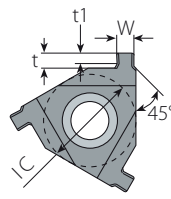

Standard
(Full Profile)

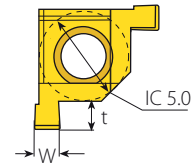

Mini-L
(Partial Profile)

Standard (Partial Profile)



Insert Size	Ordering Code	Groove Std.	Dimensions mm			Anvil	Holder
IC		m (H13)	W	t			
3/8"	3IR1.10-D472-1.30...	1.10	1.19	1.30	Y13M-1.5N	AVR..-3	
	3IR1.30-D472-1.50...	1.30	1.39	1.50			
	3IR1.60-D472-1.80...	1.60	1.69	1.80			
	3IR1.85-D472-2.00...	1.85	1.94	2.00			

Range of profiles also available on IC 1/4", 1/2" and 5/8", inserts on request.
For minimum bore diameters, refer to page 9.

Standard (Full Profile)



Insert Size	Ordering Code	Groove Std.	Dimensions mm				Anvil	Holder
IC		m (H13)	d1	W	t1	t		
3/8"	3IR1.10C-D472-0.50...	1.10	18-22	1.19	0.36	0.50	Y13M-1.5N	AVR..-3
	3IR1.30C-D472-0.60...	1.30	24-26	1.39	0.44	0.60		
	3IR1.30C-D472-0.70...	1.30	28-30	1.39	0.60	0.70		
	3IR1.30C-D472-0.85...	1.30	31-34	1.39	0.75	0.85		
	3IR1.60C-D472-0.85...	1.60	34	1.69	0.75	0.85		
	3IR1.60C-D472-1.00...	1.60	35-38	1.69	0.85	1.00		
	3IR1.85C-D472-1.25...	1.85	40-48	1.94	1.10	1.25		
	3IR2.15C-D472-1.50...	2.15	50-63	2.24	1.35	1.50		

Range of profiles also available on IC 1/4", 1/2" and 5/8", inserts on request.
For minimum bore diameters, refer to page 9.

Mini-L (Partial Profile)



Insert Size	Ordering Code	Groove Std.	Dimensions mm		Min. Bore dia (mm)	Holder
IC		m (H13)	W	t		
5.0L	5LIR0.9-D472-0.7...	0.9	0.99	0.7	8.0	.NVR10..-5L
	5LIR1.1-D472-1.0...	1.1	1.19	1.0		
	5LIR1.3-D472-1.5...	1.3	1.39	1.5		

DIN 7993 Snap Ring Grooves

External

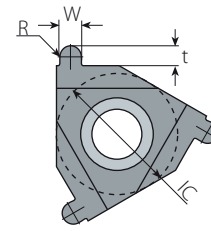
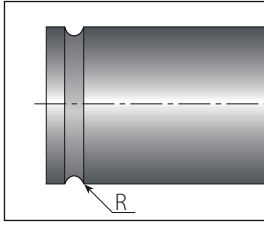

Standard
(Partial Profile)

Standard (Partial Profile for Shafts)



Insert Size	Ordering Code	Dimensions mm			Anvil	Holder
IC	RH	R	W	t		
3/8"	3ER0.40-D7993-0.60...	0.40	0.80	0.60	YE3M-1.5N	AL...3
	3ER0.60-D7993-0.80...	0.60	1.20	0.80		
	3ER0.90-D7993-1.10...	0.90	1.80	1.10		
	3ER1.00-D7993-1.20...	1.00	2.00	1.20		

Range of profiles also available on IC 1/4", 1/2" and 5/8", inserts on request.

Internal

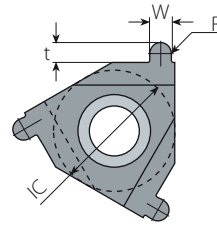
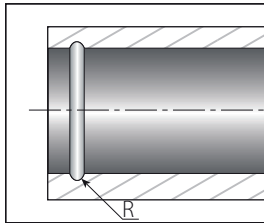

Standard
(Partial Profile)

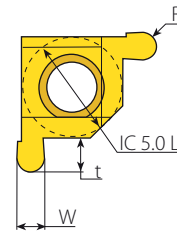

Mini-L
(Partial Profile)

Standard (Partial Profile for Bores)



Insert Size	Ordering Code	Dimensions mm			Anvil	Holder
IC	RH	R	W	t		
3/8"	3IR0.60-D7993-0.80...	0.60	1.20	0.80	YI3M-1.5N	AVR...3
	3IR0.90-D7993-1.10...	0.90	1.80	1.10		
	3IR1.00-D7993-1.20...	1.00	2.00	1.20		

Range of profiles also available on IC 1/4", 1/2" and 5/8" inserts on request.
For minimum bore diameters, refer to page 9.

Mini-L (Partial Profile for Bores)



Insert Size	Ordering Code	Dimensions mm			Min Bore dia.	Holder
IC	RH	R	W	t	mm	
5.0L	5LIR0.4-D7993-0.8...	0.4	0.8	0.8	8.0	.NVR10-5L
	5LIR0.6-D7993-1.0...	0.6	1.2	1.0		

DIN 76 Thread Undercuts (For ISO Metric Threads in Accordance with DIN 13)

External

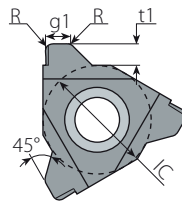
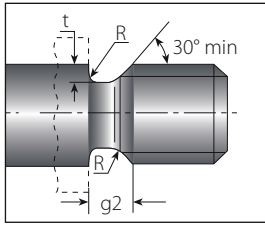

Normal - Type A

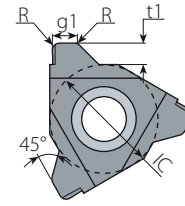

Short - Type B

Standard (Normal - Type A)



Insert Size	Ordering Code	Pitch	Dimensions mm					Anvil	Holder
IC	RH	mm	R	g1	g2	t	t1		
3/8"	3ER0.50-D76ST-0.40...	0.50	0.2	1.10	1.50	0.40	2.50	YE3M-1.5N	AL..-3
	3ER0.60-D76ST-0.50...	0.60	0.4	1.30	1.80	0.50	2.40		
	3ER0.70-D76ST-0.55...	0.70	0.4	1.55	2.10	0.55	2.20		
	3ER0.80-D76ST-0.65...	0.80	0.4	1.75	2.40	0.65	2.10		
5/8"	3ER1.00-D76ST-0.80...	1.00	0.6	2.20	3.00	0.80	1.90	YE5M-1.5N	AL..-5
	5ER1.25-D76ST-1.00...	1.25	0.6	2.80	3.80	1.00	3.60		
	5ER1.50-D76ST-1.15...	1.50	0.8	3.35	4.50	1.15	3.30		
	5ER1.75-D76ST-1.30...	1.75	1.0	4.00	5.30	1.30	3.00		
	5ER2.00-D76ST-1.50...	2.00	1.0	4.50	6.00	1.50	2.70		

Standard (Short - Type B)



Insert Size	Ordering Code	Pitch	Dimensions mm					Anvil	Holder
IC	RH	mm	R	g1	g2	t	t1		
3/8"	3ER1.00-D76SH-0.80...	1.00	0.6	1.20	2.00	0.80	2.50	YE3M-1.5N	AL..-3
	3ER1.25-D76SH-1.00...	1.25	0.6	1.50	2.50	1.00	2.30		
	3ER1.50-D76SH-1.15...	1.50	0.8	1.85	3.00	1.15	2.10		
	3ER1.75-D76SH-1.30...	1.75	1.0	2.20	3.50	1.30	1.90		
5/8"	5ER2.00-D76SH-1.50...	2.00	1.0	2.50	4.00	1.50	3.80	YE5M-1.5N	AL..-5
	5ER2.50-D76SH-1.80...	2.50	1.2	3.20	5.00	1.80	3.50		
	5ER3.00-D76SH-2.20...	3.00	1.6	3.80	6.00	2.20	3.10		

Range of profiles also available on IC 1/4" and 1/2" inserts on request.

DIN 76 Thread Undercuts (For ISO Metric Threads in Accordance with DIN 13)

Internal

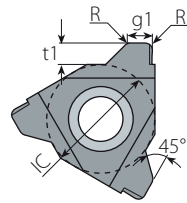
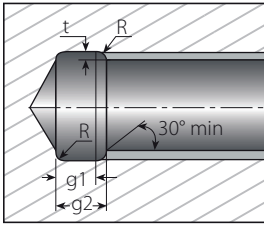

Normal - Type C

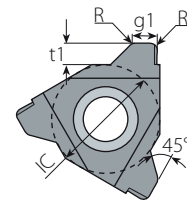

Short - Type D

Standard (Normal - Type C)



Insert Size	Ordering Code	Pitch	Dimensions mm					Anvil	Holder
IC	RH	mm	R	g1	g2	t	t1		
3/8"	3IR0.50-D76ST-0.40...	0.50	0.2	1.10	1.50	0.40	2.50	Y13M-1.5N	AVR...-3
	3IR0.60-D76ST-0.50...	0.60	0.4	1.30	1.80	0.50	2.40		
	3IR0.70-D76ST-0.55...	0.70	0.4	1.55	2.10	0.55	2.20		
	3IR0.80-D76ST-0.65...	0.80	0.4	1.75	2.40	0.65	2.10		
	3IR1.00-D76ST-0.80...	1.00	0.6	2.20	3.00	0.80	1.90		

Range of profiles also available on IC 1/4", 1/2" and 5/8" inserts on request.
For minimum bore diameters, refer to page 9.

Standard (Short - Type D)



Insert Size	Ordering Code	Pitch	Dimensions mm					Anvil	Holder
IC	RH	mm	R	g1	g2	t	t1		
3/8"	3IR1.00-D76SH-0.80...	1.00	0.6	1.20	2.00	0.80	2.50	Y13M-1.5N	AVR...-3
	3IR1.25-D76SH-1.00...	1.25	0.6	1.50	2.50	1.00	2.30		
	3IR1.50-D76SH-1.15...	1.50	0.8	1.85	3.00	1.15	2.10		
	3IR1.75-D76SH-1.30...	1.75	1.0	2.20	3.50	1.30	1.90		

Range of profiles also available on IC 1/4", 1/2" and 5/8" inserts on request.
For minimum bore diameters, refer to page 9.

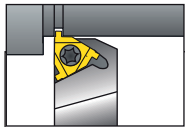

External Toolholders

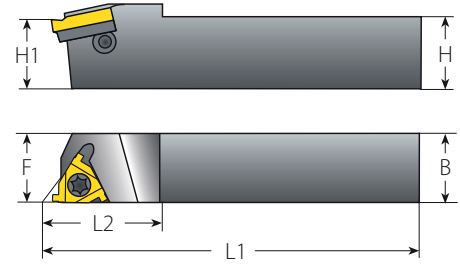
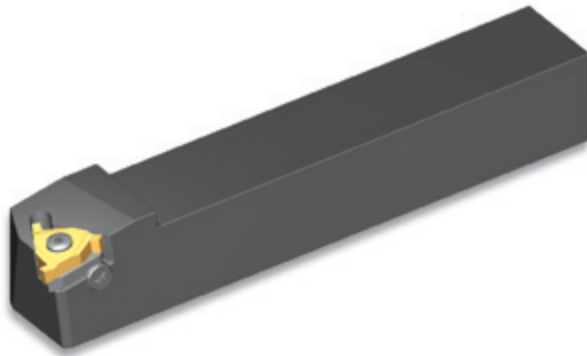

Standard

Spare Parts

Insert Size	Ordering Code		Dimensions mm							
	IC	RH	H=H1=B	F	L1	L2	Insert Screw	Anvil Screw	Torx Key	Anvil RH
1/4"		NL8-2	8	11	136.4	17.5	SN2T	-	K2T	-
		NL10-2	10	11	70.0	17.5				
		NL12-2	12	12	80.0	17.5				
3/8"		AL3/8-3	9.52	16	63.6	20.5	SA3T	SY3T	K3T	YE3M-1.5N
		AL12-3	12	16	100.0	22.0				
		AL16-3	16	16	82.3	20.5				
		AL20-3	20	20	128.6	30.0				
		AL25-3	25	25	153.6	30.0				
1/2"		AL32-3	32	32	173.6	30.0	SA4T	SY4T	K4T	YE4M-1.5N
		AL25-4	25	25	155.7	36.0				
		AL32-4	32	32	175.7	36.0				
5/8"		AL40-4	40	40	205.7	36.0	SA5T	SY5T	K5T	YE5M-1.5N
		AL25-5	25	32	151.6	35.0				
		AL32-5	32	32	176.6	40.0				
		AL40-5	40	40	206.6	40.0				
	AL50-5	50	50	256.6	40.0					

* The toolholders are supplied with standard anvils. For Grooving, please use the anvils indicated in the table above. For ordering code see page 2.

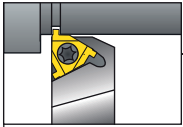

External Toolholders

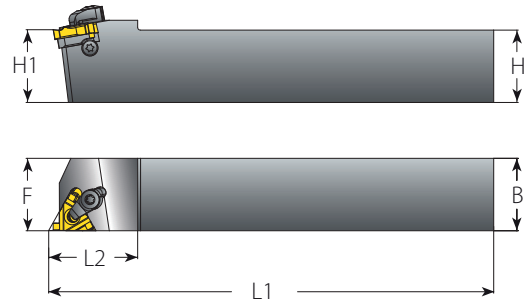

Standard with Clamp (Dual System, Screw or Clamp)

Spare Parts

Insert Size	Ordering Code	Dimensions mm				Spare Parts				
		H=H1=B	F	L1	L2	Insert Screw	Anvil Screw	Clamp	Torx Key	Anvil LH
3/8"	AL16-3C	16	16	100.0	20.5	SA3T	SY3T	C3	K3CT	YE3M-1.5N
	AL20-3C	20	20	128.6	30					
	AL25-3C	25	25	153.6	30					
	AL32-3C	32	32	173.6	30					
1/2"	AL25-4C	25	25	155.7	36	SA4T	SY4T	C4	K4T	YE4M-1.5N
	AL32-4C	32	32	175.7	36					
	AL40-4C	40	40	205.7	36					
5/8"	AL25-5C	25	32	151.6	35	SA5T	SY5T	C5	K5T	YE5M-1.5N
	AL32-5C	32	32	176.6	40					
	AL40-5C	40	40	206.6	40					
	AL50-5C	50	50	256.6	40					

* The toolholders are supplied with standard anvils. For Grooving, please use the anvils indicated in the table above.
For ordering code see page 2.

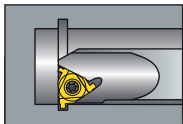

Internal Toolholders

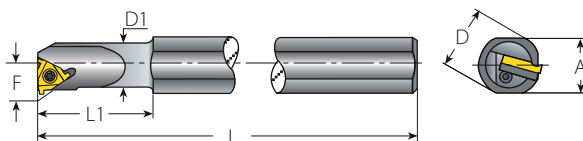

Standard

Spare Parts

Insert Size	Ordering Code	Dimensions mm							Min Bore Dia.				
IC	RH	A	L	L1	D	D1	F	mm	Insert Screw	Anvil Screw	Torx Key	Anvil RH	
1/4"	NVR10D-2		100		10	10.0	7.3	13					
	NVR10-2	18.0	180	25	20	10.0	7.3	13	SN2T	-	K2T	-	
	NVR13-2	18.0	180	32	20	13.0	8.9	16					
3/8"	NVR13-3	18.0	180	32	20	12.7	10.3	17					
	NVR16-3	18.0	180	40	20	16.0	11.5	20	SN3T	-	K3T	-	
	NVR16D-3	15.2	150	32	16	16.0	11.3	20					
	AVR20-3	18.0	180	40	20	20.0	13.4	24					
	AVR25-3	29.0	250	60	32	25.0	16.3	29					
1/2"	AVR25D-3	22.6	200	45	25	24.6	16.1	29	SA3T	SY3T	K3T	YI3M-1.5N	
	AVR32-3	29.0	250	60	32	32.0	19.6	36					
	AVR40-3	36.0	300	60	40	40.0	23.8	44					
	NVR20-4	18.0	180	50	20	20.0	15.6	27	SN4T	-	K4T	-	
5/8"	AVR25-4	29.0	250	60	32	25.0	17.4	32					
	AVR25D-4	22.6	200	45	25	24.6	17.2	32	SA4T	SY4T	K4T	YI4M-1.5N	
	AVR32-4	29.0	250	60	32	32.0	21.5	39					
	AVR40-4	36.0	300	60	40	40.0	25.8	47					
1"	AVR32-5	29.0	250	60	32	32.0	22.4	40	SN5T	SY5T	K5T	YI5M-1.5N	
	AVR40-5	36.0	300	60	40	40.0	26.4	48					
	AVR50-5	45.0	350	75	50	50.0	31.4	58	SA5T	SY5T	K5T	YI5M-1.5N	
	AVR60-5	54.0	400	75	60	60.0	36.4	69					

* The toolholders are supplied with standard anvils. For Grooving, please use the anvils indicated in the table above. Holders with coolant channel available as standard. For ordering code see page 2.

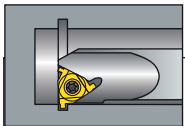

Internal Toolholders

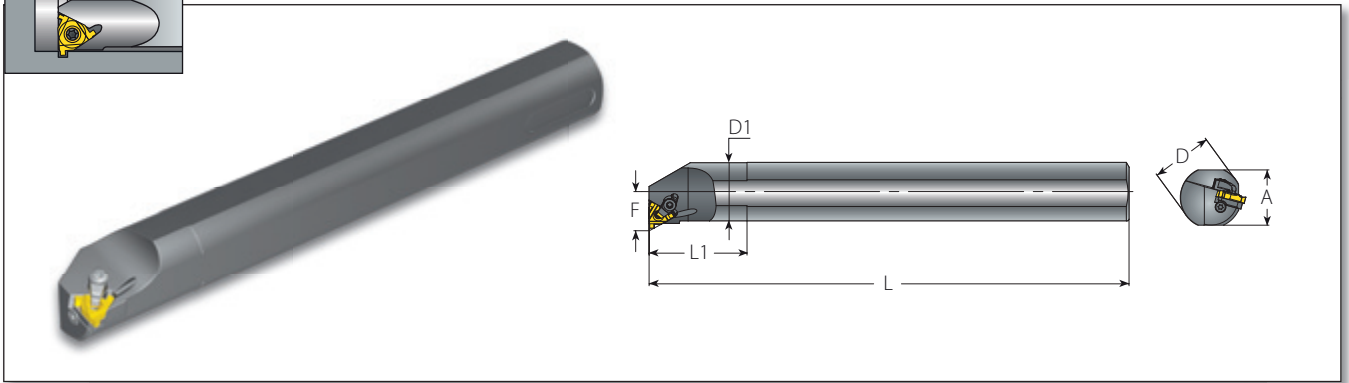

Standard with Clamp

(Dual System, Screw or Clamp)

Spare Parts

Insert Size	Ordering Code	Dimensions mm						Min Bore Dia.					
		IC	RH/LH	A	L	L1	D		D1	F	mm	Insert Screw	Anvil Screw
3/8"	AVR20-3C	18.0	180	50	20	20.0	13.4	24	SA3T	SY3T	C3	K3CT	YI3M-1.5N
	AVR25-3C	28.0	250	60	32	25.0	16.3	29					
	AVR25D-3C	22.6	200	45	25	24.6	16.1	29					
	AVR32-3C	29.0	250	60	32	32.0	19.6	36					
1/2"	AVR40-3C	36.0	300	60	40	40.0	23.8	44	SA4T	SY4T	C4	K4T	YI4M-1.5N
	AVR25-4C	29.0	250	60	32	25.0	17.4	32					
	AVR25D-4C	22.6	200	45	25	24.6	17.2	32					
	AVR32-4C	29.0	250	60	32	32.0	21.5	39					
5/8"	AVR40-4C	36.0	300	60	40	40.0	25.8	47	SN5T	SY5T	C5	K5T	YI5M-1.5N
	AVR32-5C	29.0	250	60	32	32.0	22.4	40					
	AVR40-5C	36.0	300	60	40	40.0	26.4	48					
	AVR50-5C	45.0	350	75	50	50.0	31.4	58					
	AVR60-5C	54.0	400	75	60	60.0	36.4	69	SA5T	SY5T	C5	K5T	YI5M-1.5N

* The toolholders are supplied with standard anvils. For Grooving, please use the anvils indicated in the table above.
 Holders with coolant channel available as standard. For ordering code see page 2.

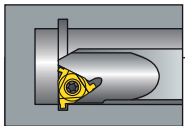

Internal Toolholders

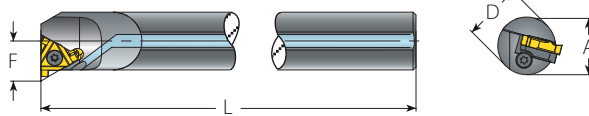

Standard with Carbide Shank

Spare Parts

Insert Size	Ordering Code		D	A	F	L	Min Bore Dia. mm	Spare Parts			
	IC	RH/LH						Insert Screw	Anvil Screw	Torx Key	Anvil RH
1/4"	CNVRC10-2		10	9.5	7.3	150	13	SN2T	-	K2T	-
	CNVRC12-2		12	11.7	8.3	180	15				
3/8"	CNVRC16-3		16	15.6	11.5	200	20	SN3T	-	K3T	-
	CAVRC20-3		20	19.5	13.4	250	24	SA3T	SY3T	K3T	YI3M-1.5N
1/2"	CNVRC20-4		20	19.5	13.8	250	25	SN4T	-	K4T	-

* The toolholders are supplied with standard anvils. For Grooving, please use the anvils indicated in the table above. The above Toolholders have coolant channel as standard.

Carbide Shank toolholders should be used when extra accuracy is required or when the bar length to bar diameter ratio exceeds 3:1.

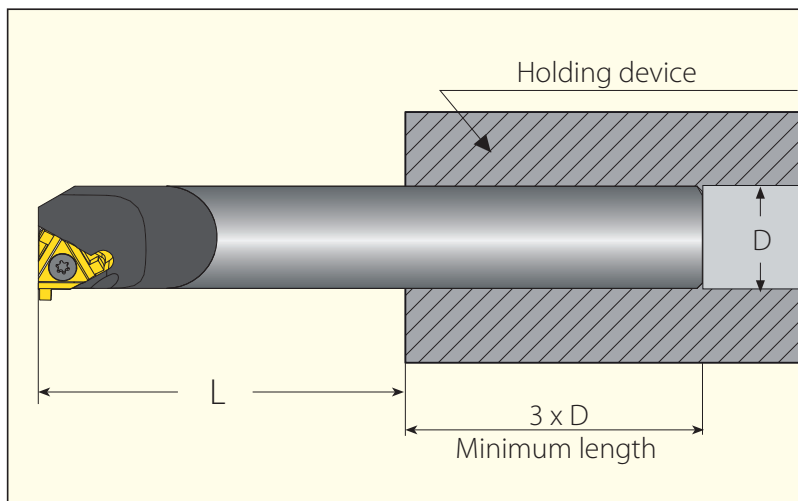

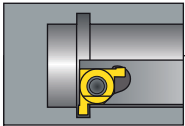

The overhang to bar diameter ratio should be as small as possible to eliminate the chance of chatter (vibration). The minimum length inside a holding device should be 3 times the diameter of the bar shank.

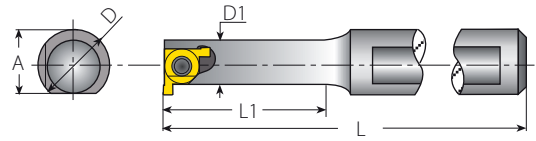

Internal Toolholders





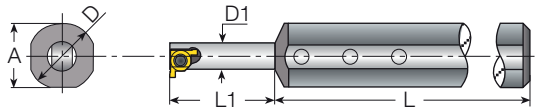
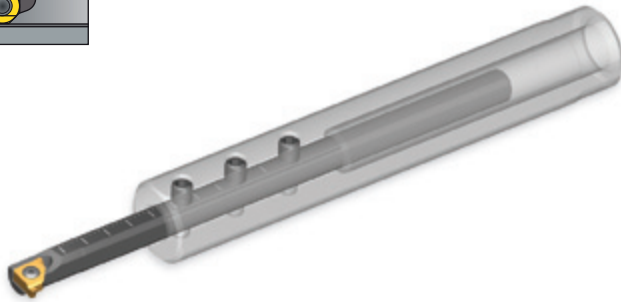
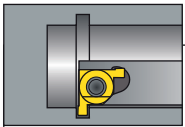

Mini-L

Insert Size	Ordering Code	Dimensions mm					Anti-Vibration System	Spare Parts			
		IC	RH	A	L	L1		D	D1		
5.0L	SNVR 10U-5L			9.4	81	16	10	6.2	No	SN5LT	K5LT
	BNVR 10S-5L			9.4	87	22	10	6.2	Carbide Implanted		
	BNVR 10M-5L			9.4	97	31	10	6.2	Carbide Implanted		
	BNVR 10L-5L			9.4	109	43	10	6.2	Carbide Implanted		



Mini-L - Adjustable





Insert Size	Ordering Code		Dimensions mm					Spare Parts				
	IC	Sleeve	Holder RH	A	L	L1	D	D1				
5.0L	SV16-6.2	BNVR6.2T-5L		15.6	100	8-44	16	6.2	SN5LT	K5LT	S4.0	K2.0

GROOVING Technical Data

Recommended Grades, Cutting Speeds Vc [m/min] and Feed f [mm/rev]

Material Group	Vargus No.	Material	Hardness Brinell HB	Vc [m/min]			Feed [mm/rev]	
				Coated				
				VTX	VKP/VKX	VHX		
P Steel	1	Unalloyed steel	Low carbon (C=0.1-0.25%)	125	140-200	140-200	20-50	0.3
	2		Medium carbon (C=0.25-0.55%)	150	120-180	120-180	15-40	0.15
	3		High Carbon (C=0.55-0.85%)	170	110-180	110-180	15-30	0.05
	4	Low alloy steel (alloying elements ≤ 5%)	Non hardened	180	100-155	100-155	20-45	0.25
	5		Hardened	275	90-145	90-145	10-25	0.1
	6		Hardened	350	80-135	80-135	10-25	0.05
	7	High alloy steel (alloying elements >5%)	Annealed	200	70-115	65-115		0.2
	8		Hardened	325	50-100	50-100		0.05
	9	Cast steel	Low alloy (alloying elements <5%)	200	30-50	30-50	25-50	0.2
	10		High alloy (alloying elements >5%)	225	20-40	25-40	20-40	0.05
M Stainless Steel	11	Stainless steel Ferritic	Non hardened	200	70-120	80-120		0.2
	12		Hardened	330	60-95	55-95		0.05
	13	Stainless steel Austenitic	Austenitic	180	70-100	60-100		0.2
	14		Super Austenitic	200	40-90	50-90		0.05
	15	Stainless steel Cast ferritic	Non hardened	200	80-110	60-80		0.2
	16		Hardened	330	65-110	45-65		0.05
	17	Cast austenitic	Austenitic	200	85-100	50-70		0.2
	18		Hardened	330	60-100	40-60		0.05
K Cast Iron	28	Malleable Cast iron	Ferritic (short chips)	130	70-120	60-80		0.2
	29		Pearlitic (long chips)	230	70-120	60-80		0.15
	30	Grey cast iron	Low tensile strength	180	70-120	60-80		0.2
	31		High tensile strength	260	60-100	40-70		0.1
	32	Nodular SG iron	Ferritic	160	50-80	60-80		0.2
	33		Pearlitic	260	60-90	70-90		0.1
N(K) Non-Ferrous Metals	34	Aluminium alloys Wrought	Non aging	60	100-240	80-240	30-60	0.4
	35		Aged	100	80-170	100-170	25-50	0.1
	36	Aluminium alloys	Cast	75	100-150	100-150	25-50	0.25
	37		Cast & aged	90	80-120	60-100	20-40	0.15
	38	Aluminium alloys	Cast Si 13-22%	130	100-150	100-150	15-30	0.15
	39	Copper and copper alloys	Brass	90	80-200	80-200	15-35	0.2
40	Bronze and non leaded copper		100	80-200	80-200	15-35	0.15	
S(M) Heat Resistant Material	19	High temperature alloys	Annealed (Iron based)	200	45-60	25-45		0.2
	20		Aged (Iron based)	280	35-50	20-30		0.05
	21		Annealed (Nickel or Cobalt based)	250	20-30	15-20		0.05
	22		Aged (Nickel or Cobalt based)	350	15-25	10-15		0.05
	23	Titanium alloys	Pure 99.5 Ti	400Rm	140-170	60-100		0.1
	24		α+β alloys	1050Rm	50-70	40-50		0.05
H(K) Hardned Material	25	Extra hard steel	Hardened & tempered	45-50HRC	45-60	20-40		0.02
	26			51-55HRC	40-50	20-35		0.02

Grades and Their Application

Grade	Application Type	Sample	Grade	Application Type	Sample
VTX	General use carbide grade. A tough sub-micron substrate with TiAlN coating. Provides good fracture toughness and excellent wear resistance.		VKP	General use carbide grade. TiN coated	
VKX	Superior general purpose grade, excellent in steels and stainless steels, recommended for rigid cutting conditions. TiN coated.		VHX	General use HSS grade. For machining at low cutting speed. TiN coated	



Laydown Grooving

For Shallow Grooves

GROOVEX

Innovative Grooving Solutions

maxmark
METRIC